

Detail Sluithaad in sluitkorn

Schroeven:  
SKH3 goedgekeurde schroeven 4x40mm

Certificaat nummer: 475.213.01

Toe te passen i.c.m. sluitkommen:  
Certificaat: 475.613.04 / 05 / 06



omschrijving

MEERPUNTSLUITINGEN SECURITY (EUROPA) SH25

GU  
G.U.-Nederland B.V.  
www.gu.nl

Bestelnummer	Bestelomschrijving	Bestelhoeveelheid	Bestelhoeveelheid in pakket	Bestelhoeveelheid in doos
201303-01		1	1	1

Frezing in het kozijn voor sluitkom hoofdstot

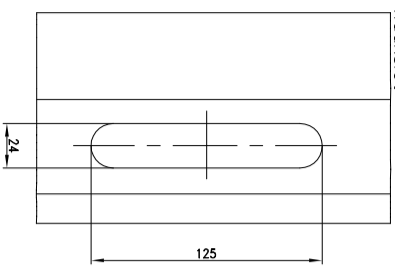

Hoofdstoot

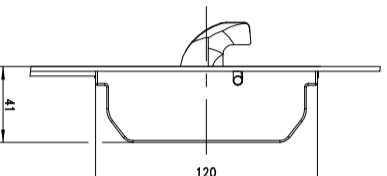

Frezing voor bijzet slotkast voor sluithaak

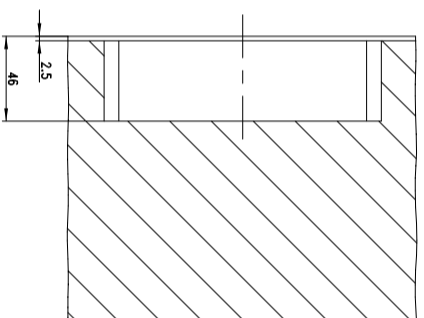

Sluithaak

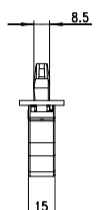
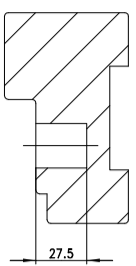
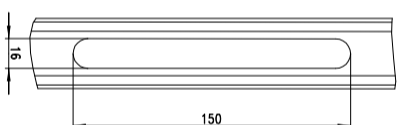

Frezing in kozijn voor sluitkom hoofdstot

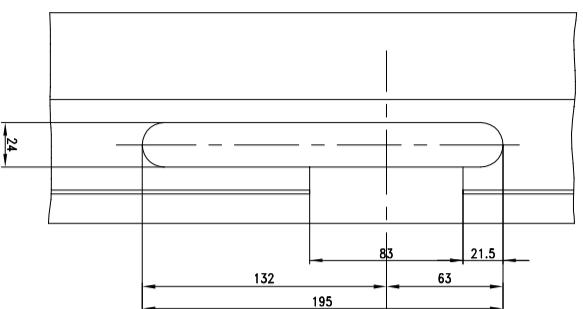

Maatvoering hoofdstotkast

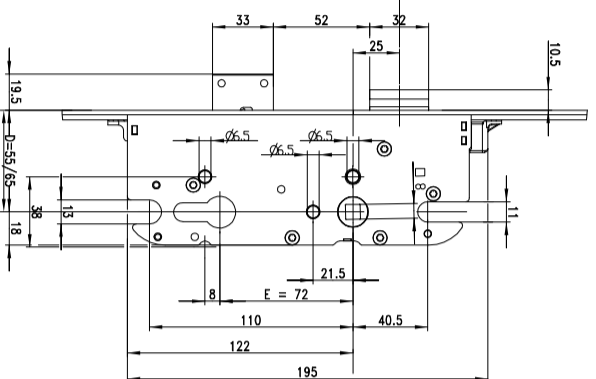

Krukgaltheogte 1050mm

Frezing voor de Hoofdstotkast

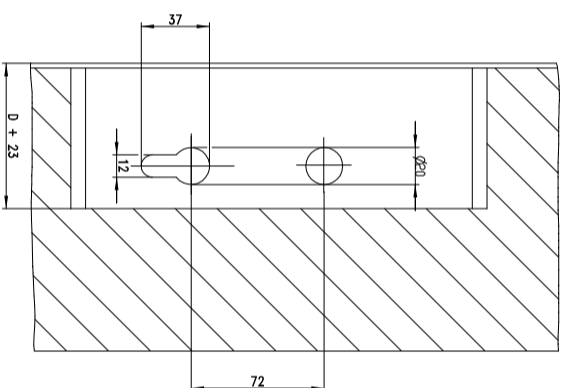

Doorsnede deur en kozijn

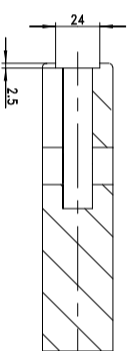
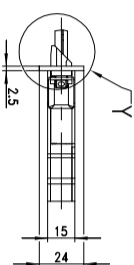
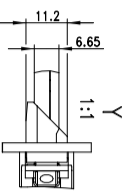
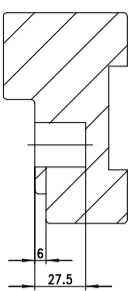
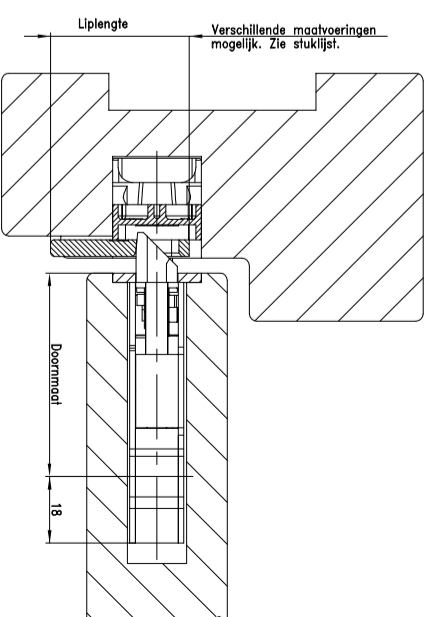

<p>Meerpuntsluitingen Security (EUROPA) SH25</p> <p>G.U.—Nederland B.V.</p> <p>www.gu.nl</p>		<p>Bestelnummer</p> <p>16-10-2017</p> <p>201303-01</p>	<p>Bladz. 1</p> <p>Totaal 2/2</p>
--	--	--	-----------------------------------